

# MODEL:ROSTHERNE BED [ SINGLE ]

## ASSEMBLY INSTRUCTION

**IMPORTANT:** READ THESE INSTRUCTIONS CAREFULLY BEFORE ASSEMBLING OR USING BED FRAME.

**PLEASE KEEP THESE INSTRUCTIONS FOR FUTURE REFERENCE.**

### **HEALTH & SAFETY:**

**DO NOT** jump on this bed frame.

**DO NOT** use this bed frame if any parts are missing, damaged or worn.

**DO NOT** use this bed frame unless all fixings are secured.

Please keep small parts out of reach of children.

Always use on a level, even surface.

**WARNING:** If this bed is placed on a non-carpeted floor you must place some protection under all legs to stop the bed frame from moving. If this is not adhered to there is no guarantee if the bed frame collapses.

### **CARE & MAINTENANCE:**

Assemble in the room of use.

Periodically check all screws & fixings to ensure they are secure.

**DO NOT** push the bed frame as this will damage the legs.





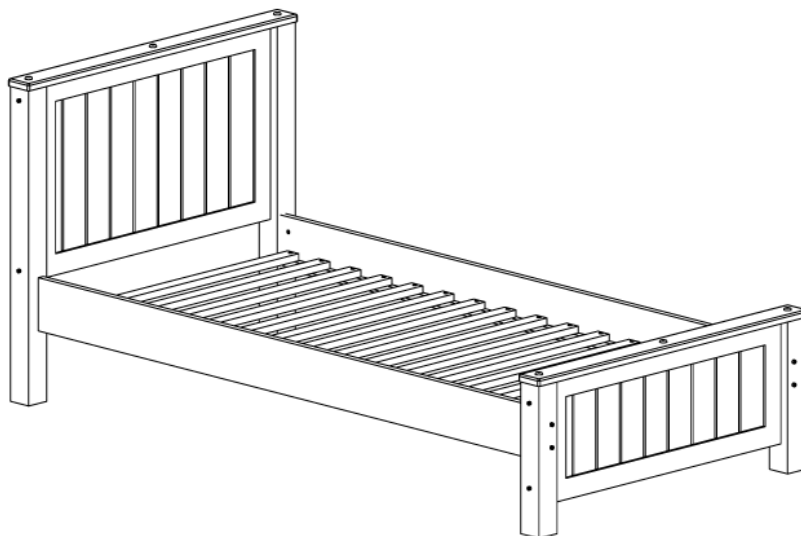

Always lift the bed with two people to reposition.



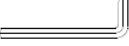



Keep any sharp objects away from the frame.



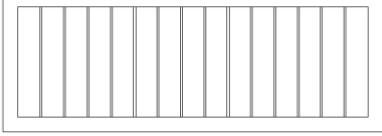
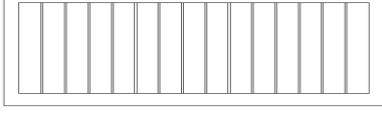
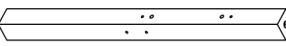
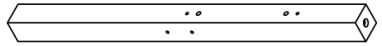

**SCREWDRIVER NOT PROVIDED**

# HARDWARE LIST

1	JCBC M6 x 100 mm	8 pcs	
2	Allen Key	1 pcs	
3	JCBC M6 x 25 mm	6 pcs	
4	CKS screw M4 x 32 mm	22 pcs	
5	Wood Dowel M8 x 40 mm	12 pcs	
6	JCBC M6 x 100 mm	8 pcs	
7	JRN Nut	8 pcs	
8	Wood Cap	6 pcs	



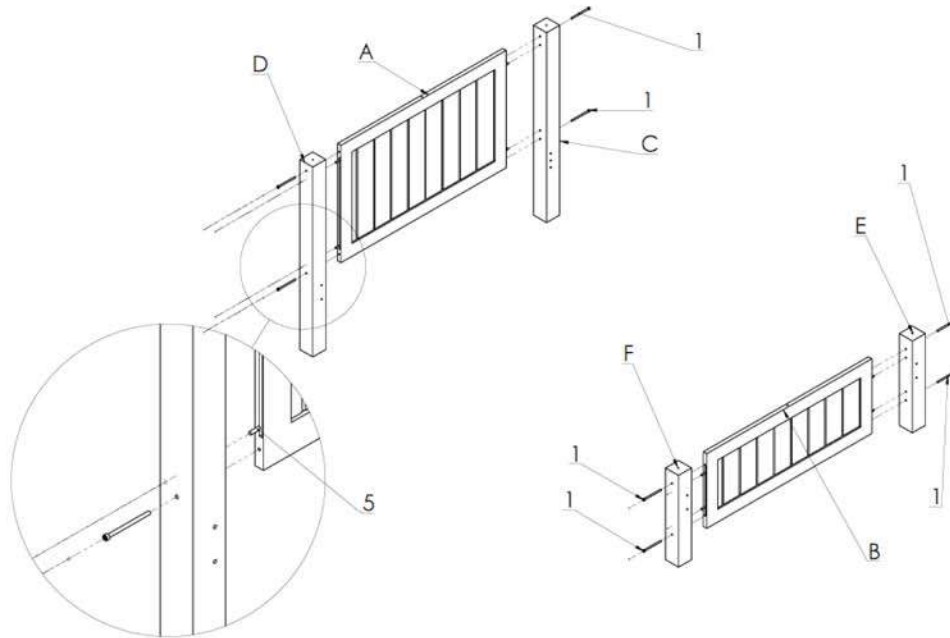

 A X 1 PC	 B X 1 PC	 C X 1 PC
 D X 1 PC	 E X 1 PC	 F X 1 PC
 G X 2 PCS	 H X 2 PCS	 I X 11 PCS

### Step 1 : Assemble Post With HB & FB

1	JCBC M6 x 100 mm	8 pcs	
2	Allen Key	1 pcs	
5	Wood Dowel M8 x 40 mm	8 pcs	

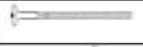

### Step 2 : Assemble side rail

6	JCBC M6 x 100 mm	8 pcs	
2	Allen Key	1 pcs	
5	Wood Dowel M8 x 40 mm	4 pcs	
7	JRN Nut	8 pcs	

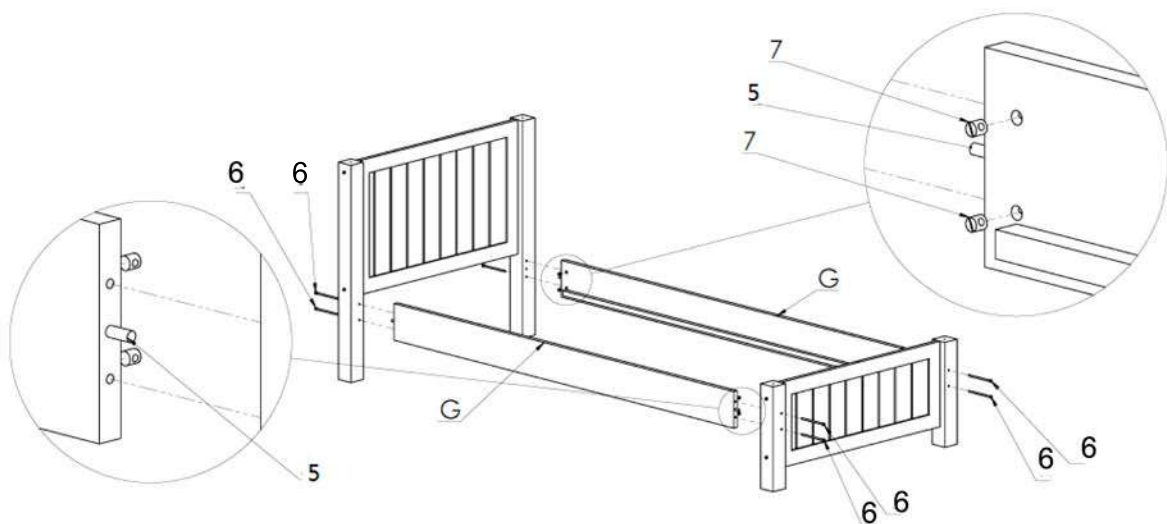

### Step 3 : Assemble Slat

4	CKS screw M4 x 32 mm	22 pcs	
---	----------------------	--------	---

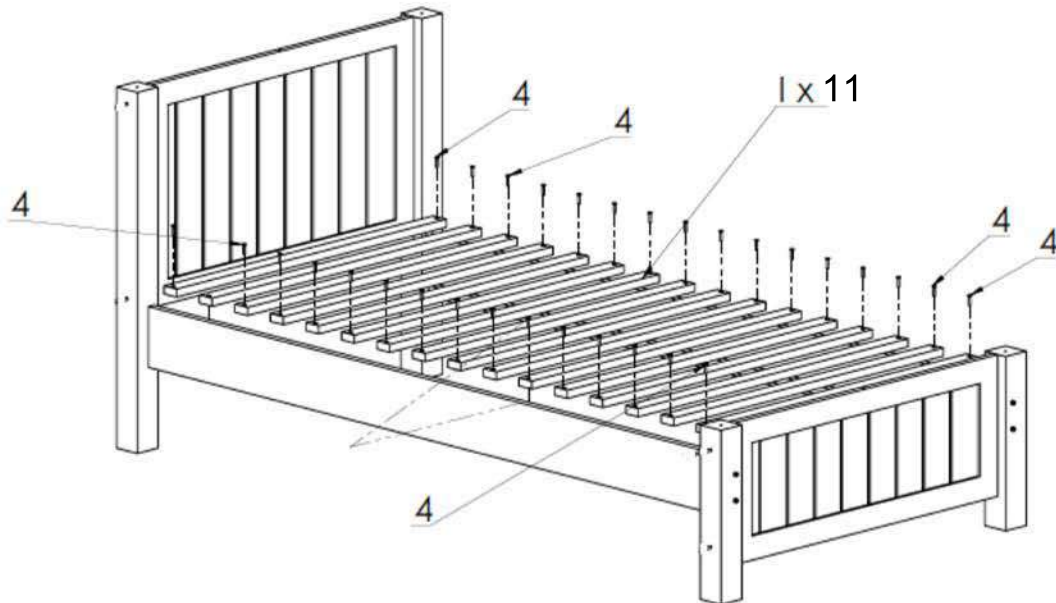

### Step 4 : Assemble Top Panel with The Bed

3	JCBC M6 x 25 mm	6 pcs	
8	Wood Cap	6 pcs	
10	Allen Key	1 pcs	