

MODEL : ROSTHERNE [DOUBLE/KING]

ASSEMBLY INSTRUCTION

IMPORTANT: READ THESE INSTRUCTIONS CAREFULLY BEFORE ASSEMBLING OR USING BED FRAME.

PLEASE KEEP THESE INSTRUCTIONS FOR FUTURE REFERENCE.

HEALTH & SAFETY:

DO NOT jump on this bed frame.

DO NOT use this bed frame if any parts are missing, damaged or worn.

DO NOT use this bed frame unless all fixings are secured.

Please keep small parts out of reach of children.

Always use on a level, even surface.

WARNING: If this bed is placed on a non-carpeted floor you must place some protection under all legs to stop the bed frame from moving. If this is not adhered to there is no guarantee if the bed frame collapses.

CARE & MAINTENANCE:

Assemble in the room of use.

Periodically check all screws & fixings to ensure they are secure.

DO NOT push the bed frame as this will damage the legs.











Always lift the bed with two people to reposition.









Keep any sharp objects away from the frame.

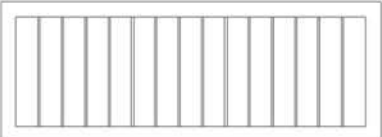
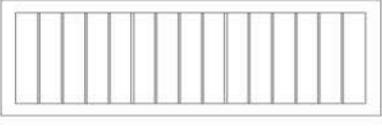
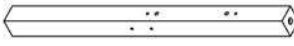
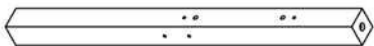



SCREWDRIVER NOT PROVIDED

HARDWARE LIST

1	JCBC M6 x 100 mm	8 pcs	
2	JCBC M6 x 30 mm	3 pcs	
3	JCBC M6 x 25 mm	8 pcs	
4	CKS screw M4 x 32 mm	56 pcs	
5	Wood Dowel M8 x 40 mm	12 pcs	
6	JCBC M6 x 100 mm	8 pcs	
7	JRN Nut	8 pcs	
8	Wood Cap	8 pcs	
9	Adjustable Feet	3 pcs	
10	Allen Key	1 pcs	



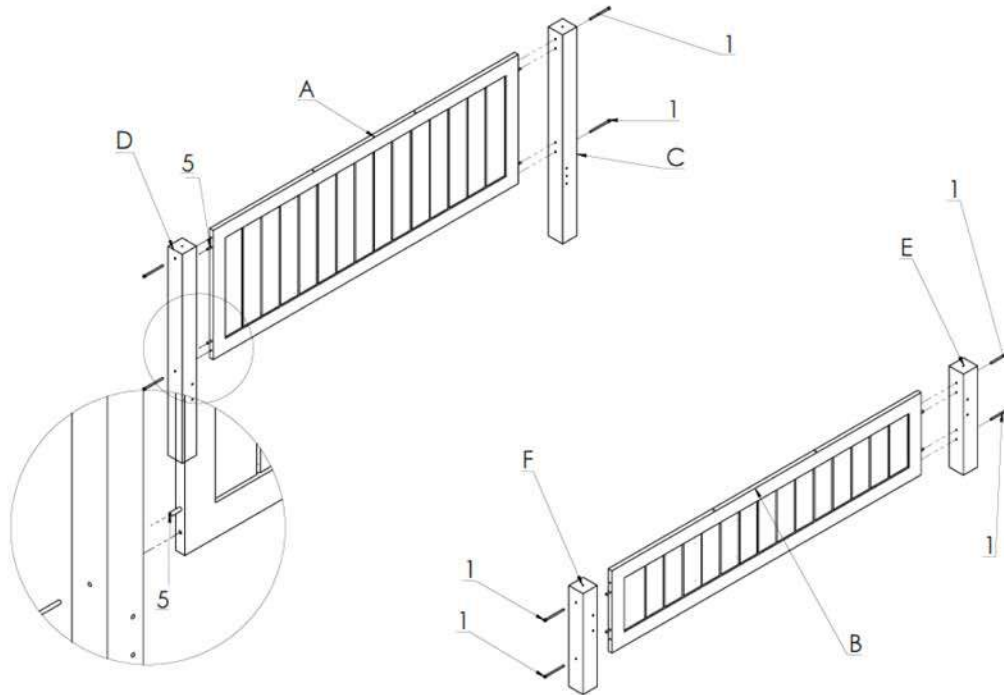

 A X 1 PC	 B X 1 PC	 C X 1 PC
 D X 1 PC	 E X 1 PC	 F X 1 PC
 G X 2 PCS	 H X 2 PCS	 I X 14 PCS
 J X 1 PC	 K X 3 PCS	

Step 1 : Assemble Post With HB & FB

1	JCBC M6 x 100 mm	8 pcs	
5	Wood Dowel M8 x 40 mm	8 pcs	
10	Allen Key	1 pcs	



Step 2 : Assemble side rail

6	JCBC M6 x 100 mm	8 pcs	
5	Wood Dowel M8 x 40 mm	4 pcs	
7	JRN Nut	8 pcs	
10	Allen Key	1 pcs	

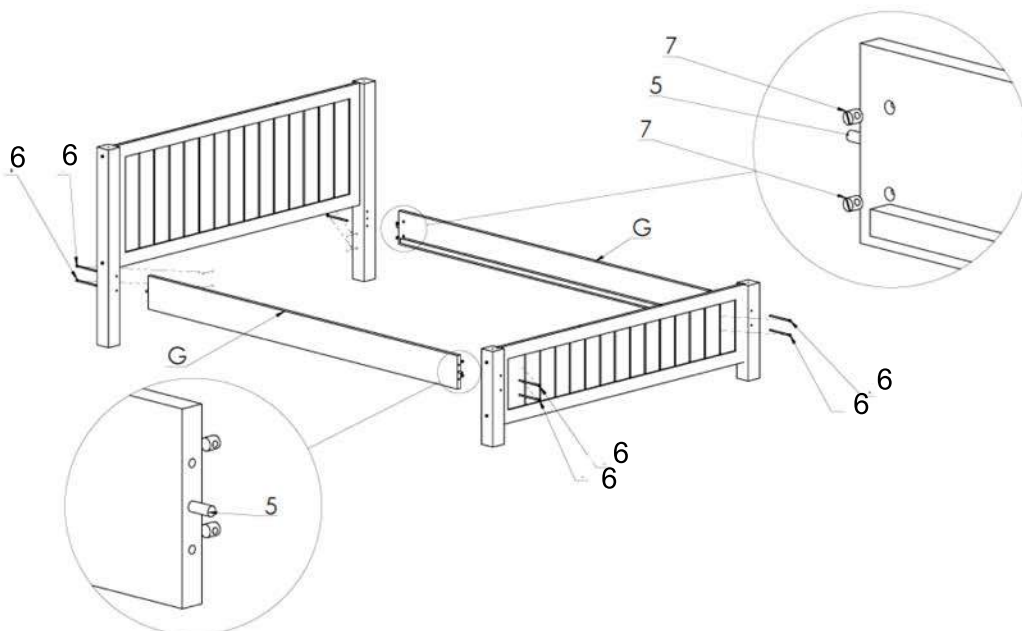

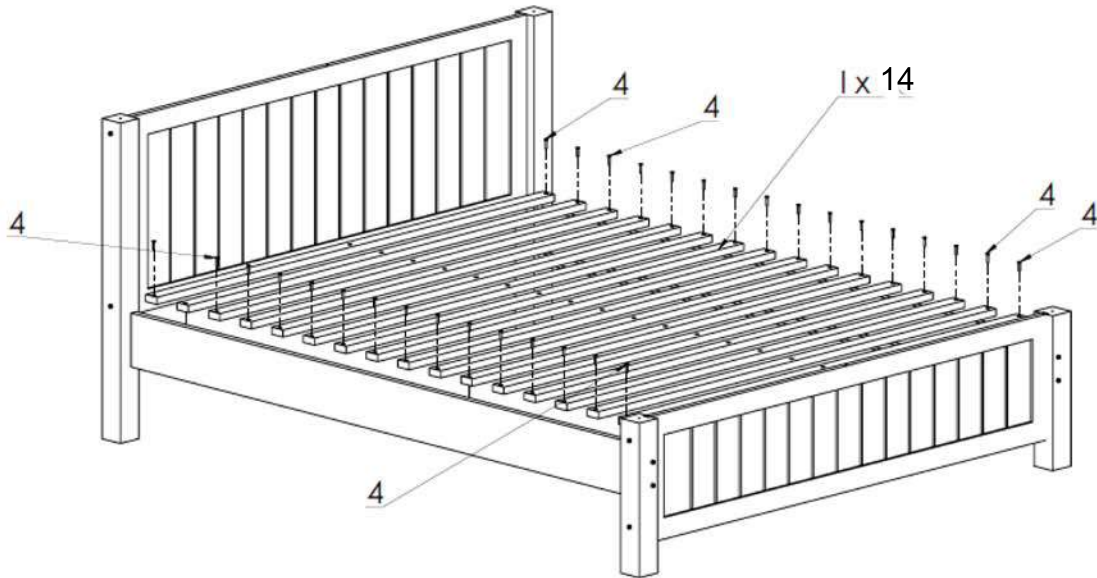

Step 3 : Assemble Slat

4	CKS screw M4 x 32 mm	28 pcs	
---	----------------------	--------	---



Step 4 : Assemble Leg Center Support

2	JCBC M6 x 40 mm	3 pcs	
9	Adjustable Feet	3 pcs	

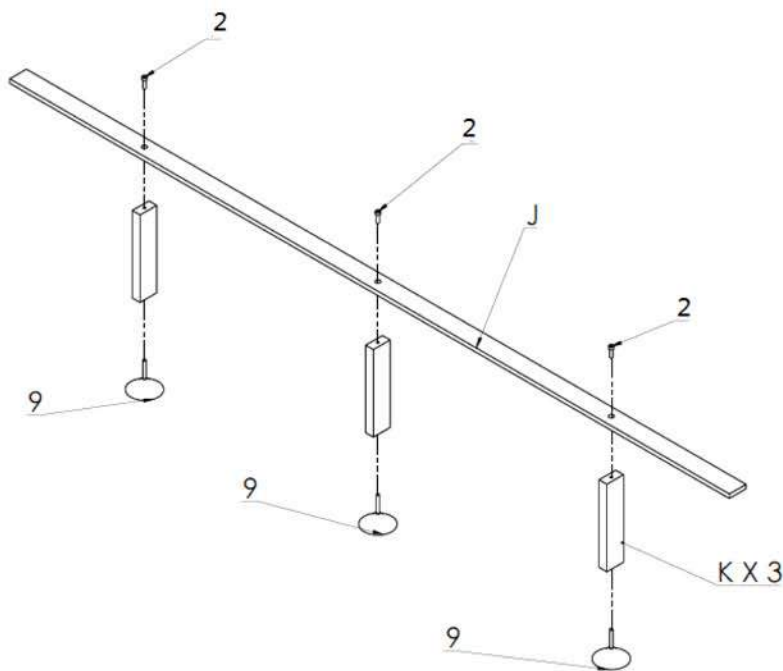

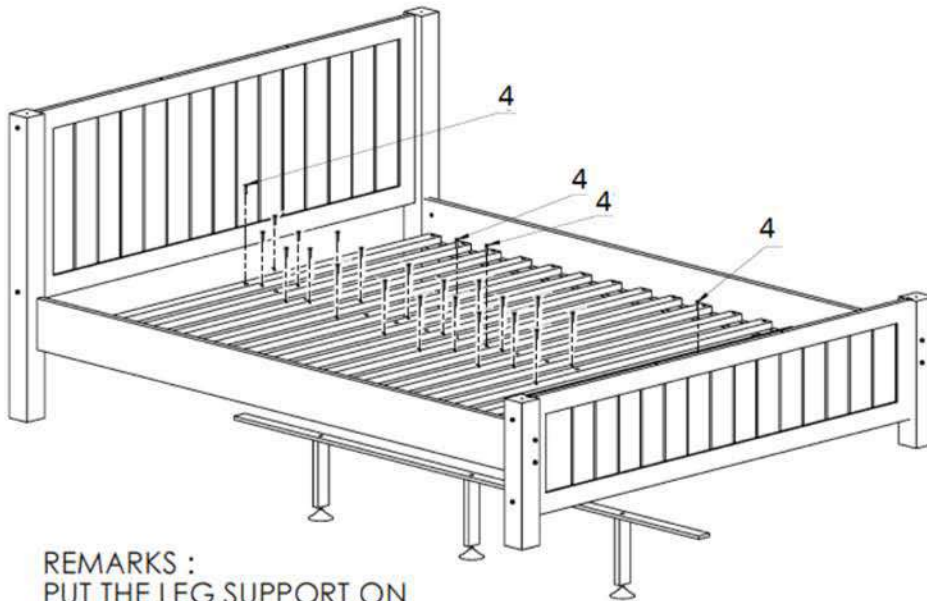

Step 5 : Assemble Leg Center Support with the Slat on Bottom of The Bed

4	CKS screw M4 x 32 mm	28 pcs	
---	----------------------	--------	---



REMARKS :
PUT THE LEG SUPPORT ON
BOTTOM OF THE BED SLAT

Step 6 : Assemble Top Panel with The Bed

3	JCBC M6 x 25 mm	8 pcs	
8	Wood Cap	8 pcs	
10	Allen Key	1 pcs	