

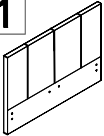

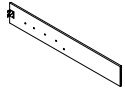

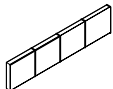

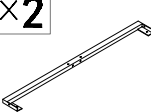

<b>A×1</b> 	<b>B×2</b> 
<b>C×1</b> 	
<b>E×2</b> 	<b>F×2</b> 
<b>G×1</b> 	<b>H×2</b> 
<b>I×2</b> 	<b>J×2</b> 
<b>K×2</b> 	<b>L×1</b> 
<b>M×1</b> 	<b>N×1</b> 
<b>O×1</b> 	<b>P×1</b> 

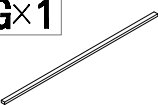

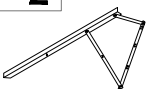
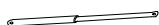
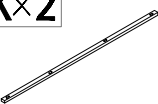
Q×22

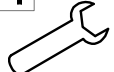

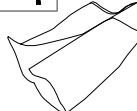
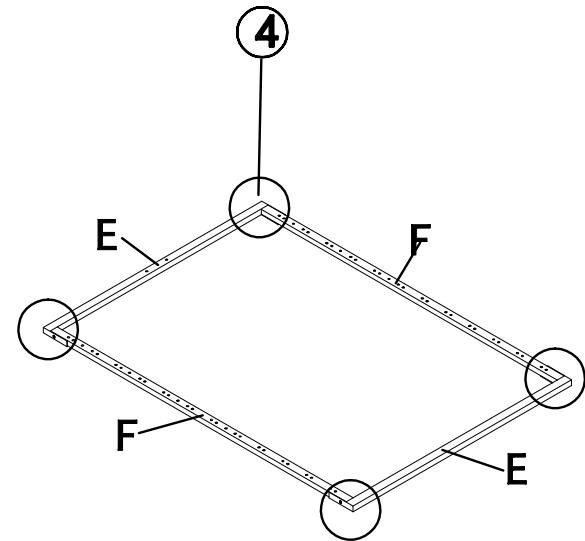
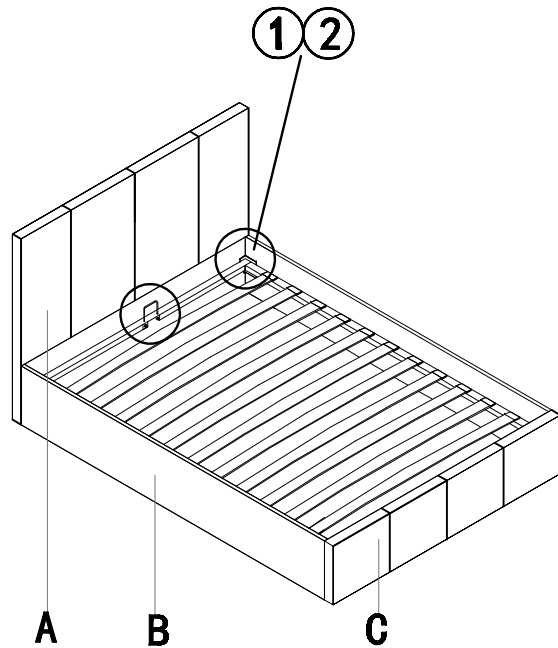
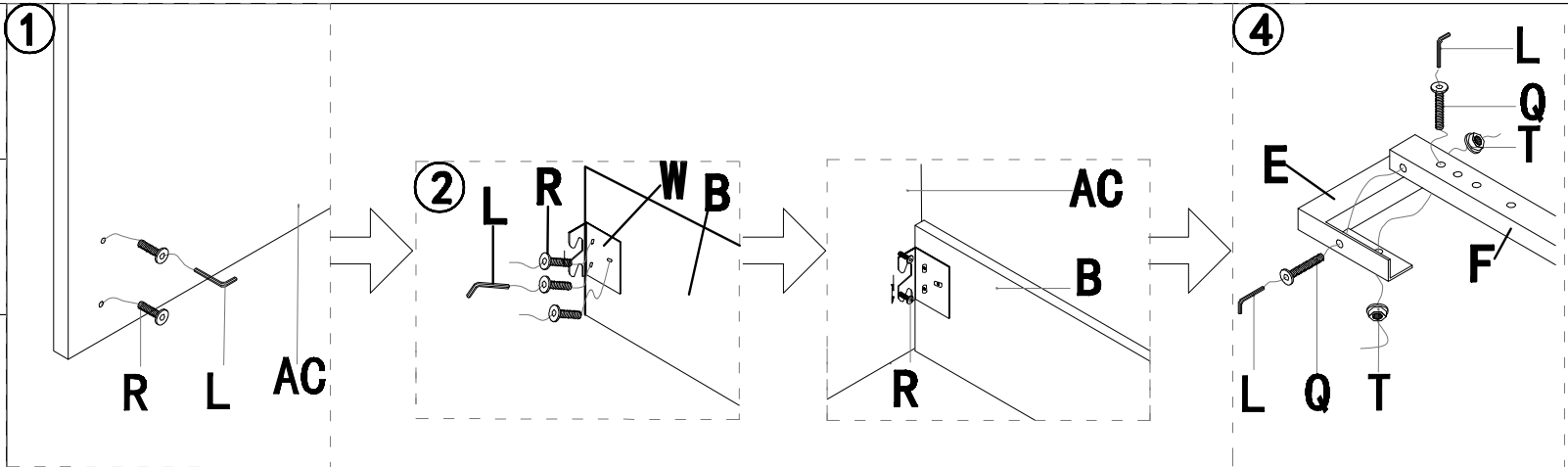
R×26



S×4



T×14



U×26

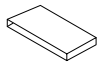

V×13

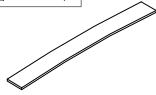

W×4

