









NESTON BED (SINGLE) ASSEMBLY INSTRUCTION

Thanks you for purchasing this quality product. Be sure to lay all components on a soft and clean surface before assembly in order to avoid components from being scratehead.

CAUTIONS :

1. Check cetents against list for quantity.
2. Familiarize yourself with the components and hardware by reviewing the assembly instructions.
3. Do not over tightened the screws and bolts as it may damage the threads.
4. Keep all hardware parts out of the reach of children.

NO	HARDWARE	QTY
1	JCBC M6 x 90 mm 	8
2	JRN Nut 	8
3	Wooden 8 x 40 	4
4	CKS Screw M4 x 32 mm 	32
5	Allen Key 	1

NO	PART LIST	QTY
A	Head Board 	1
B	Foot Board 	1
C	Side Rails 	2
D	Slats Set (8 pcs) 	2

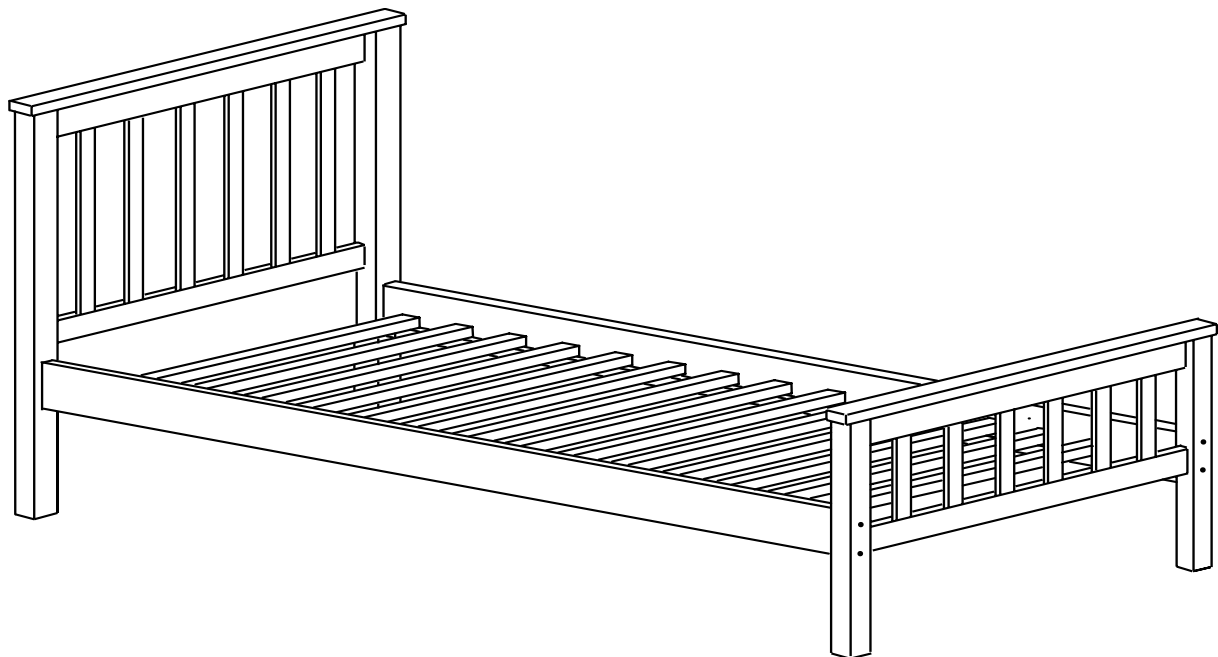

Step 1 : Assemble side rail

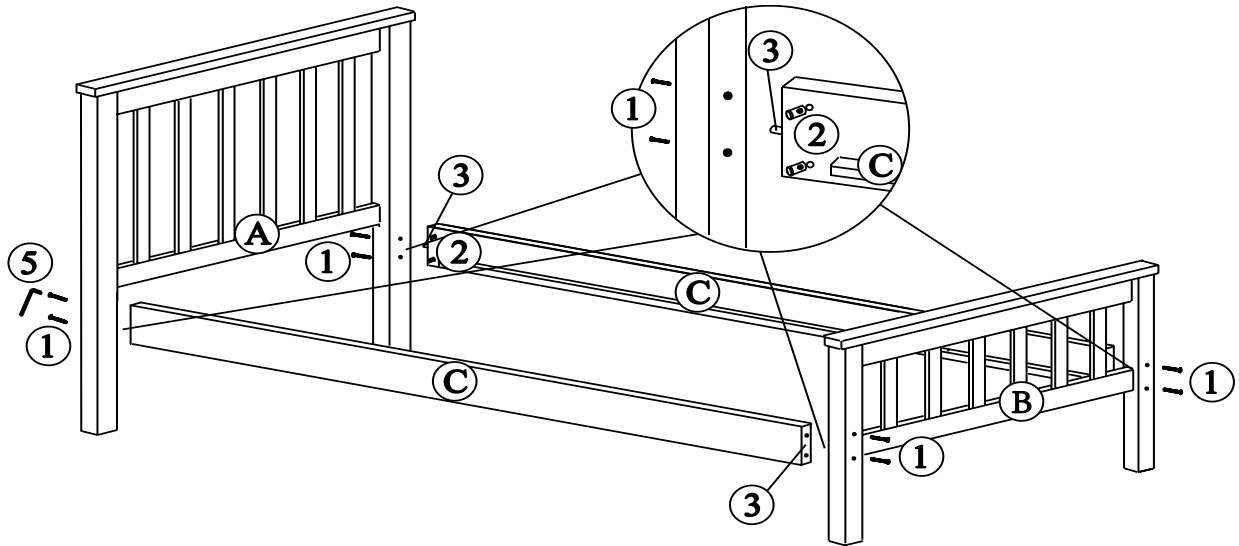

Step 2 : Assemble the slat

