

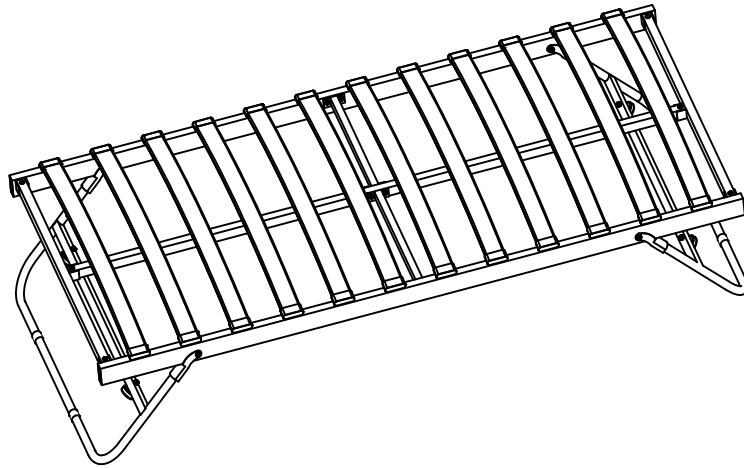

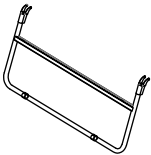

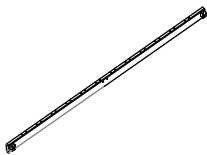

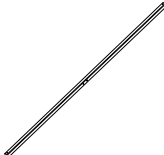

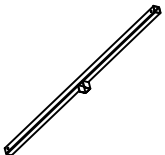

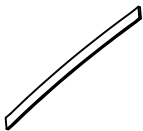

# ASSEMBLY INSTRUCTIONS

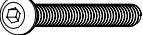
## MODEL: HARLOW DAY BED & TRUNDLE

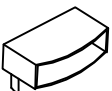
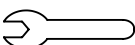
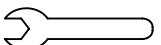

<p>1. Feet 2 pcs</p> 	<p>2. Siderails 2 pcs</p> 	<p>3. Centre bar 1 pc</p> 	<p>4. Cross bar 2 pcs</p> 
<p>5. Connect tube 2 pcs</p> 	<p>6. Slat 12 pcs</p> 	<p>7. Wheel 4 pcs</p> 	<p>A. M6 x 12mm 4pcs</p> 
<p>B. M6 x 35mm 6pcs</p> 	<p>C. M6 x 40mm 2pcs</p> 	<p>D. M8 x 50mm 4pcs</p> 	<p>E. Nut 12pcs</p>  <p style="text-align: center;">M6</p>
<p>F. Nut 4pcs</p>  <p style="text-align: center;">M8</p>	<p>G. Plastic cap 24pcs</p> 	<p>H. M6 Spanner 1pc</p> 	<p>I. M8 Spanner 1pc</p> 
<p>J. M6 Allen Key 2pcs</p> 	<p>K. M8 Allen Key 2pcs</p> 		

# STEP 1

INSTRUCTION

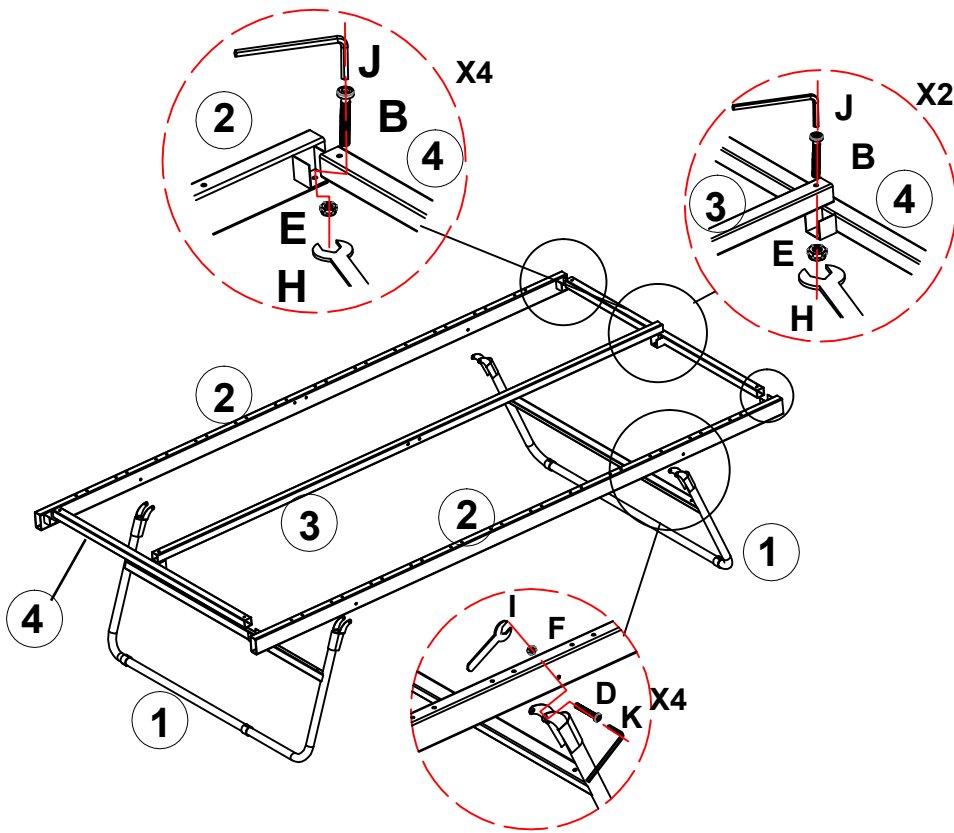

# STEP 2

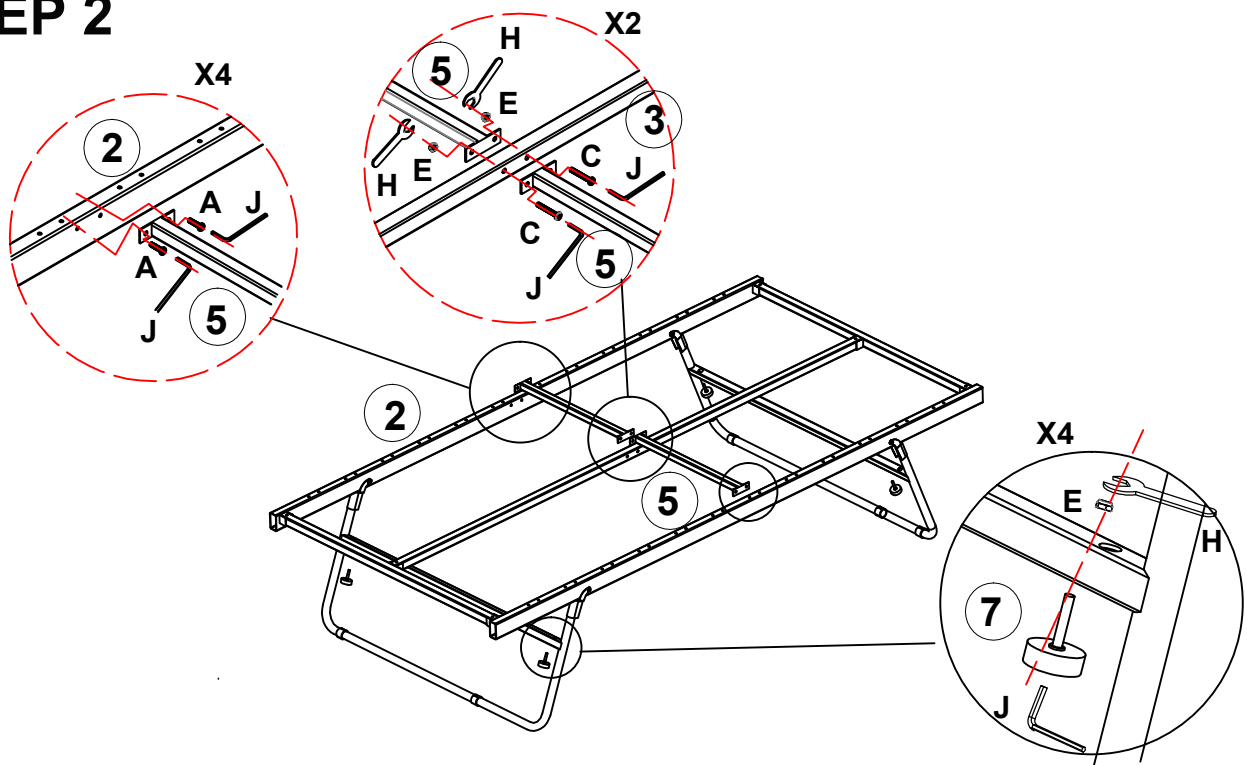

# STEP 3

