

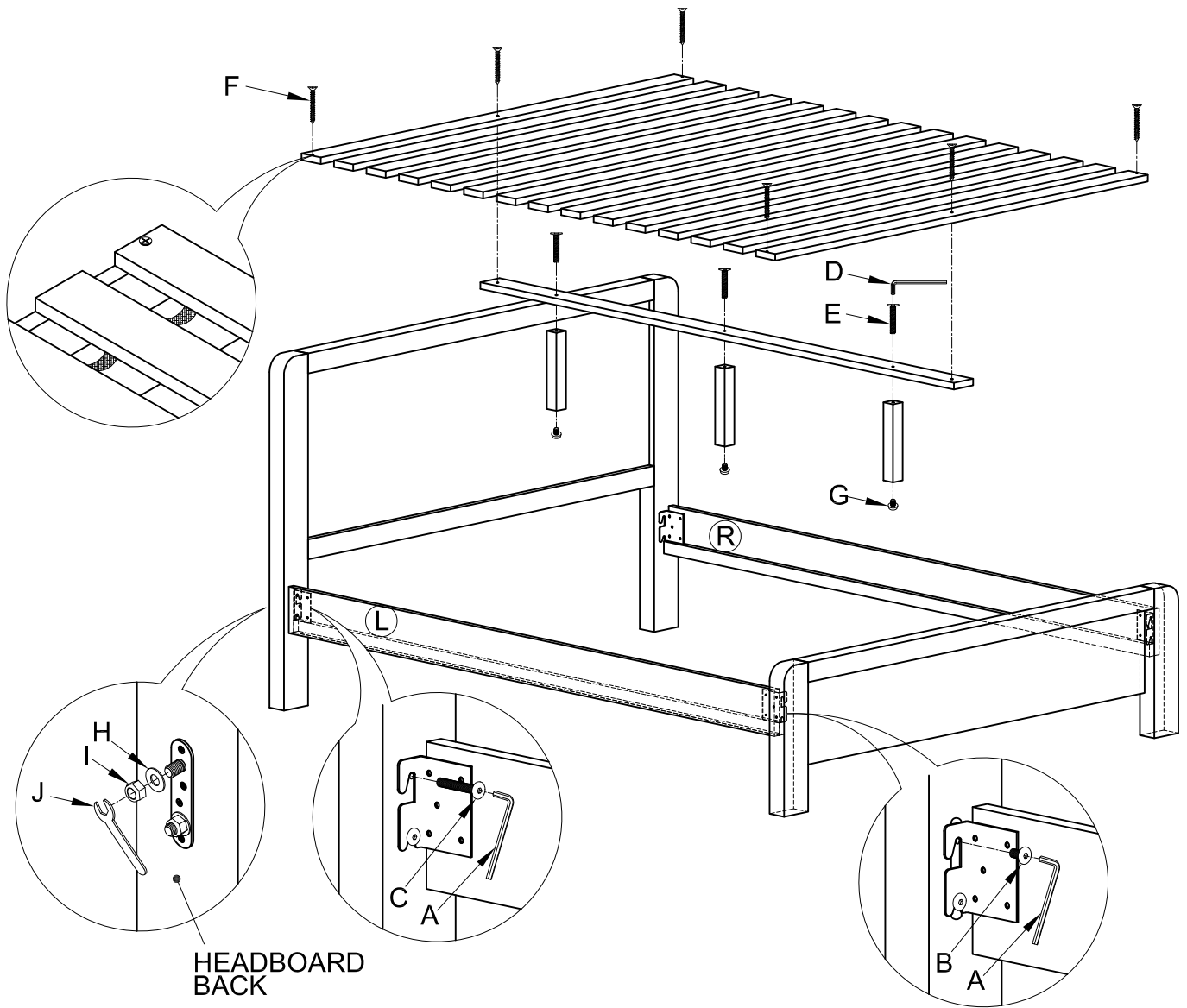





ASSEMBLY INSTRUCTION

CHESTER BED

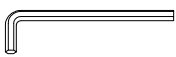
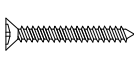
Thank you for purchasing this quality product. Please check all packing material carefully which may have come loose inside the carton during-shipment. Identify and count all parts referring to the Part List below.

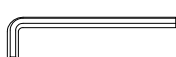

HARDWARE LISTS

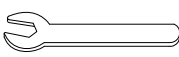
| NO | DESCRIPTION | QTY | NO | DESCRIPTION | QTY |
|----|--|-----|----|---|-----|
| A |  ALLEN KEY M5 | 1 | F |  SCK SCREW M4 x 32mm | 6 |
| B |  JCBB BOLT M8 x 16mm | 4 | G |  ADJUSTABLE LEG | 3 |
| C |  JCBB BOLT M8 x 40mm | 4 | H |  M8 WASHER | 4 |
| D |  ALLEN KEY M4 | 1 | I |  M8 HEXAGON NUT | 4 |
| E |  JCBC BOLT M6 x 30mm | 3 | J |  WRENCH | 1 |