

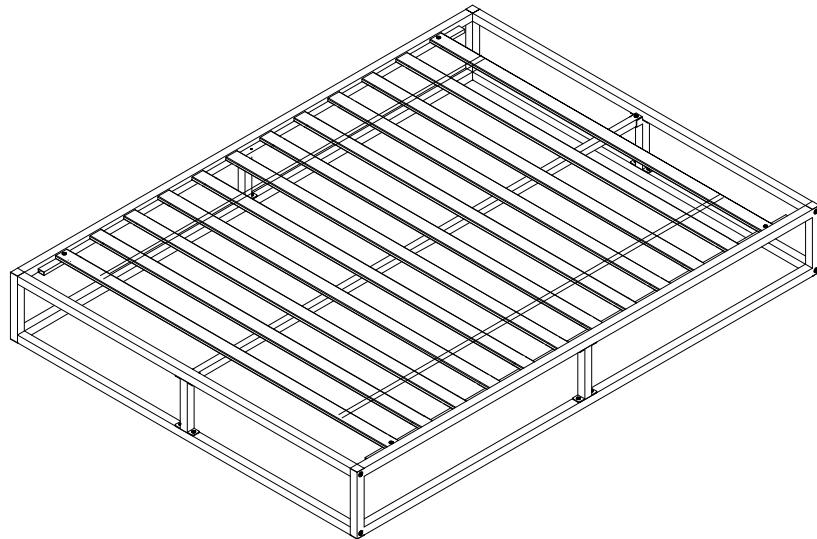

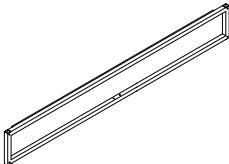

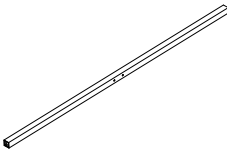

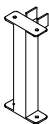
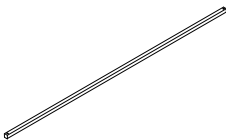
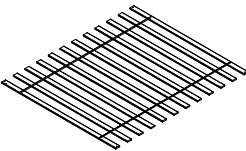

ASSEMBLY INSTRUCTIONS

MODEL: AMERSHAM PLATFORM BED(SINGLE)

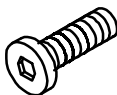
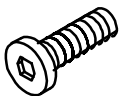

<p>1. Side frame 2pcs</p> 	<p>2. Cross tube 4pcs</p> 	<p>3. Side frame support 2pcs</p> 	<p>4. Cross tube support 2pcs</p> 
<p>5. Centre tube 1pc</p> 	<p>6. Wood slat 13pcs</p> 	<p>A. M6*16MM 16pcs</p> 	<p>B. M6*35MM 2pcs</p> 
<p>C. M6*50MM 8pcs</p> 	<p>D. M6*25MM 6pcs</p> 	<p>E. M6 2pcs</p> 	<p>F. Washer 8pcs</p> 
<p>G. M4 Allen key 2pcs</p> 	<p>H. Spanner 1pc</p> 		

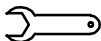
STEP 1

Note: Please expand the side rail tube outward when fix the side frame supports

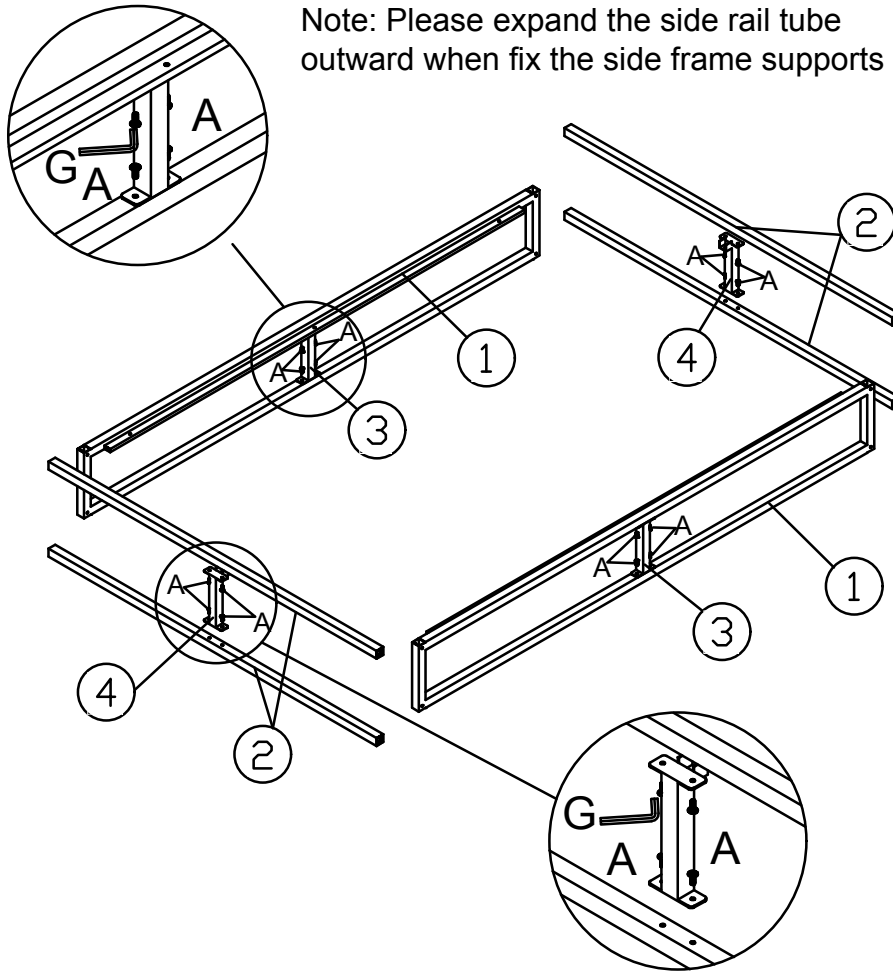

STEP 2

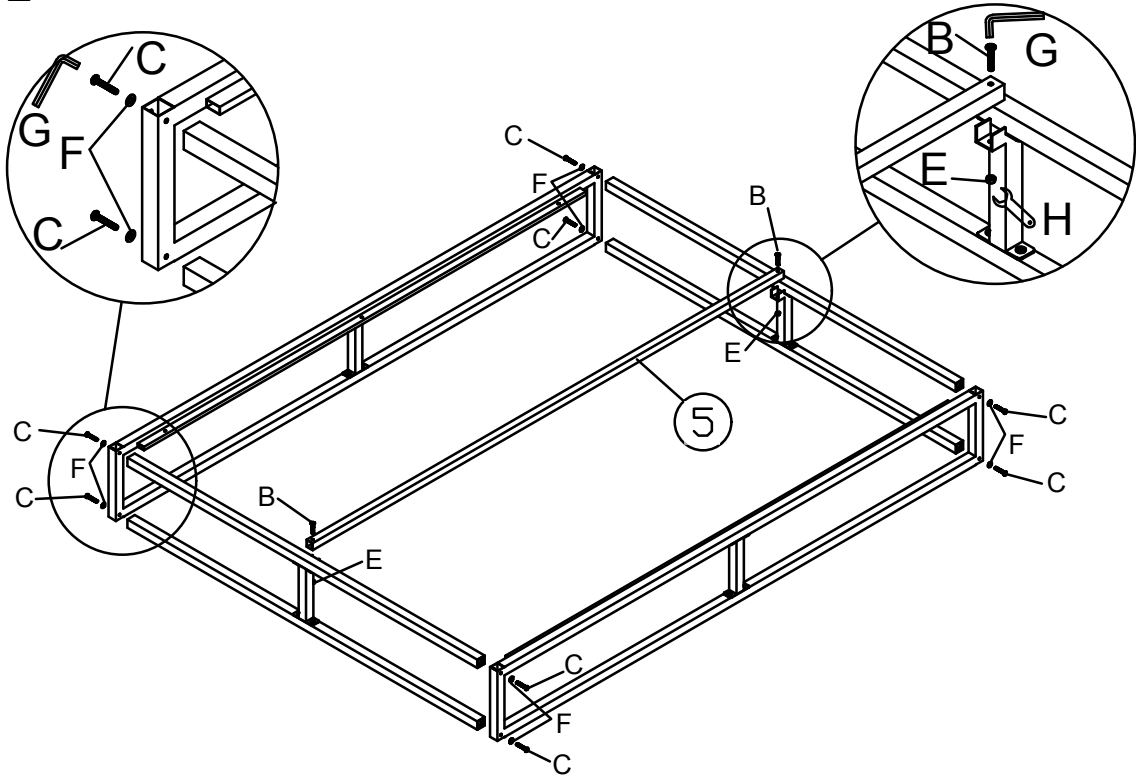

STEP 3

